

SHUTTERS | BLOCKS | VENTS

PONTIAC TRAIL®

HOME DETAILS TO LIVE BY





Standard
Mounting Block

Standard Mounting
Block w/ Universal
Electrical Box

Pontiac Trail's mission is to maximize the joy associated with selling, installing, and living in a home featuring our products by providing **simple yet elegant design solutions.**

MODERNIZED SIDING ACCESSORIES

**We have modernized
the siding accessory
market with our
updated appearance
and user-friendly
designs, all while
delivering a
streamlined product
portfolio.**

SHUTTER OFFERING

Decorative shutters for the exterior of your home

Raised Panel

14.5" & 12" widths



Open Louver

14.5" & 12" widths



Board & Batten*

4 board (14.5") &
3 board (11") widths



Available in the following standard heights: 31", 35", 39", 43", 47", 51", 55", 59", 63", 67", 71", 75", 81"
Includes shutter plugs and screws & caps | Limited lifetime warranty | Made in the USA
Available in 9 standard colors | Custom heights available: 28-81" in 0.50" increments

Shutter colors shown are Navy Night Sky (104) & Cornerstone Grey (410)

* Board & Batten has 2 battens on heights 31"- 54.5" and 3 battens on 55" and larger

SIZING YOUR SHUTTERS IS EASY

SELECTING SHUTTER WIDTHS

Window width over 24": Use 14.5" shutter

Window width under 24": Use narrow width (11" or 12")

Mixing shutter widths on a house can add a custom, elegant look.



SELECTING SHUTTER HEIGHTS

There are many ways to position shutters on a window:

Shutter Size: Size of window opening
Position: Outside window opening

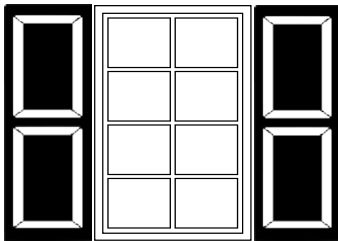

Shutter Size: Size of window opening
Position: Over window trim

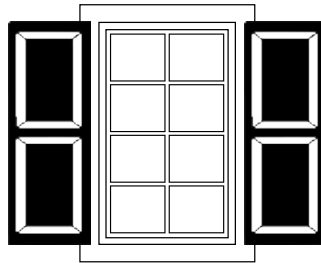

Shutter Size: Size of window trim
Position: Outside window trim

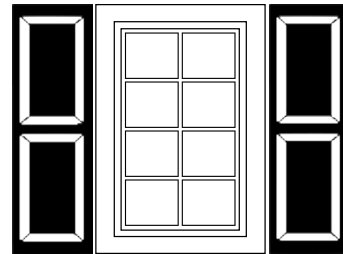

When selecting a standard height shutter, choose the size that is closest to the window trim or opening size. If the height falls between two standard shutter heights, select the larger size.

MOUNTING BLOCKS



Standard Mounting Block

7.875" x 8.875"
Outer Dimension



Receptacles, exterior lights, security cameras, and more



Accepts the universal electrical box

Siding pocket depths
0.75", 1", 1.25", 1.5"



Available in all major siding manufacturer colors



Can be installed horizontally or vertically

Individually wrapped
for clean jobsite arrival



Large Mounting Block

8.875" x 13"
Outer Dimension



Coach lights, HE furnace penetrations, and more



Accepts the universal electrical box

Siding pocket depths
0.75", 1", 1.25", 1.5"



Available in all major siding manufacturer colors



Can be installed horizontally or vertically

Individually wrapped
for clean jobsite arrival



Split Mounting Block

7.75" x 9.375"
Outer Dimension



Hose penetrations, existing receptacles, AC lines, and more



Siding pocket depths
0.75", 1", 1.25", 1.5"



Available in all major siding manufacturer colors



Can be installed in either vertical position

Individually wrapped
for clean jobsite arrival

DESIGNED WITH FUNCTIONALITY IN MIND

With an emphasis on usability, our designs offer a simplified siding accessory program requiring fewer components. We strive to enhance the experience for distributors, installers, and homeowners.

INDIVIDUALLY WRAPPED

Mounting Blocks & the Universal Electrical Box are individually wrapped to ensure the product arrives to the jobsite clean.



COMPATIBLE WITH MOST SIDING TYPES

Mounting blocks have a pocket depth ranging from 0.75"-1.5". This is a great option for siding types such as: vinyl, insulated vinyl, fiber cement, engineered wood, engineered composites, polymer shake & shingle, and more.

DIMENSIONS

Standard Mounting Block



Large Mounting Block



Split Mounting Block



STANDARD MOUNTING BLOCK

Applications: Receptacles, Exterior Lights, Security Cameras, and more



7.875" x 8.875"
Outer Dimension



Receptacles, exterior lights,
security cameras, and more



Accepts the
universal electrical box

Siding pocket depths
0.75", 1", 1.25", 1.5"



Available in all major siding
manufacturer colors



Can be installed
horizontally or vertically

**Individually
wrapped**
for clean jobsite arrival

THE ULTIMATE SNAP-FIT FEEL (ALL BLOCKS & VENTS)

Our patent-pending designs click into place in a way you can hear and feel. Special grooves in our trim-ring flex more, allowing us to add a bigger locking tooth. This combination provides the best siding accessory "snap-fit" available.

WIDE TRIM-RING (ALL MOUNTING BLOCKS)

Our trim-ring is the widest in the industry. It extends 1.25" from the block edge to cover siding cuts. Because the trim-ring is wider, cut tolerances are less crucial.

LARGE MOUNTING BLOCK

Applications: Coach Lights, HE Furnace Penetrations, Exterior Lights, and more



8.875" x 13"
Outer Dimension



Coach lights, HE furnace penetrations, and more



Accepts the universal electrical box

Siding pocket depths
0.75", 1", 1.25", 1.5"



Available in all major siding manufacturer colors



Can be installed horizontally or vertically

Individually wrapped
for clean jobsite arrival

PREMIUM LOOK, SIMPLE UPKEEP (ALL BLOCKS & VENTS)

Our blocks and vents have a premium stippled texture. This provides a high-end, modern appearance while still being easy to clean.

UNIVERSAL ELECTRICAL BOX

Applications: Receptacles, Exterior Lights, and more



INSTALLS OVER WALL SUBSTRATE

The Universal Electrical Box can be installed over house wrap/ exterior substrate, allowing for a minimal wall penetration.

PAIRS WITH MOUNTING BLOCKS

Designed to be used with the Standard and Large Mounting Blocks. Our mounting blocks have grooves that align with slots in the electrical box.

The Universal Electrical Box is sold separately from the Mounting Block to simplify quoting, inventory, and installation.



Cut along the receptacle score line on the back of the block



Attach Universal Electrical Box to wall



Install Mounting Block over Universal Electrical Box

THE UNIVERSAL ELECTRICAL BOX ALIGNS WITH OUR MOUNTING BLOCK GUIDES

The Universal Electrical Box features grooves that align with guides on both the Standard and Large Mounting Blocks. Each block contains a score line to be used with the Universal Electrical Box. The Large Mounting Block has two sets of score lines and guides, enabling a centered or offset installation of the Universal Electrical Box. (the offset design is particularly beneficial for coach lights)

Standard Mounting Block



Large Mounting Block

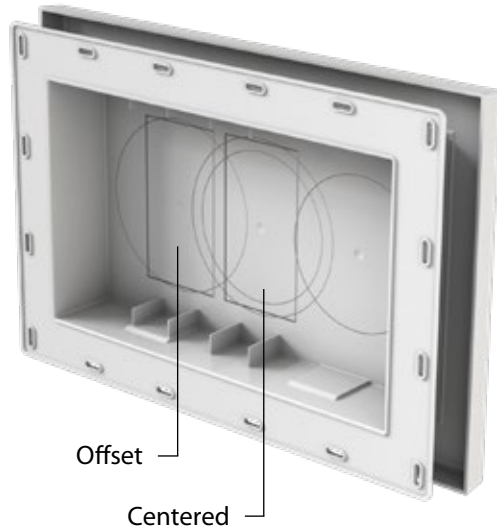

SPLIT MOUNTING BLOCK

Applications: Hose penetrations, existing receptacles, AC lines, and more



7.75" x 9.375"
Outer Dimension



Hose penetrations, existing
receptacles, AC lines, and more

Siding pocket depths
0.75", 1", 1.25", 1.5"



Available in all major siding
manufacturer colors



Can be installed in
either vertical position

**Individually
wrapped**
for clean jobsite arrival

LARGE OPENING

Our Split Block offers the largest opening available in the industry. With user convenience in mind, this opening provides more access when using hose spigots.

THE OFFSET HOLE PROVIDES FLEXIBILITY FOR BEST SPIGOT ACCESS

The split block features an offset hole, allowing for installation in either vertical direction. This flexibility allows installers to position the mounting block in the best orientation for each specific hose spigot, ensuring easy access to nozzles or handles.



High Offset



Low Offset

Our design provides versatile access to the vast array of hose spigots on the market.

UTILITY VENTS & GABLE VENTS



**4"
Hooded Vent**

8.5" x 7.5"
Outer Dimension



Exhaust only

Used for
Sidewall
Venting Applications



4" tube
diameter

Can be used as a
Dryer Vent

Pocket Depths
0.75", 1", 1.25", 1.5"

12.34 sq.in.
Open Area



**Hooded -
MultiVersal I/E Vent**

12.5" x 12.5"
Outer Dimension



Intake/ Exhaust

Used for
Sidewall
Venting Applications



4" or 6" tube
diameter

Can be used as a
Dryer Vent

Pocket Depths
0.75", 1", 1.25", 1.5"

28.3 sq.in.
Max Open Area

Ability to
Caulk
around the perimeter



**Directional -
MultiVersal I/E Vent**

11" x 10.25"
Outer Dimension



Intake/ Exhaust

Used for
Soffit, Sidewall, & Gable
Venting Applications



3", 4", or 6" tube
diameter



Pocket Depths
0.5", 0.75", 1", 1.25", 1.5"

28.3 sq.in.
Max Open Area

Ability to
Caulk
around the perimeter



**17" x 23"
Gable Vent**

16.5" x 22.5"
Outer Dimension



Intake/ Exhaust

Used for
Gable
Venting Applications



Pocket Depths
0.75", 1", 1.25", 1.5"

48 sq.in.
Open Area

Ability to
Caulk
around the perimeter

MULTIVERSAL

Multiple Universal Features

- **Siding Applications:** Able to use flange (vinyl, metal, composite) or caulk around the perimeter (fiber cement, engineered wood).
- **Vent Applications:** Able to use as an intake or exhaust.
- **Tube Sizes:** Able to accept multiple tube sizes.



Hooded - MultiVersal I/E Vent

HOODED - MULTIVERSAL I/E VENT

Sidewall applications: Intake (furnace, hot water heater, and more) or exhaust (dryer vent, furnace, bathroom fan, range fan, and more)



12.5" x 12.5"
Outer Dimension



Intake/ Exhaust

Used for
Sidewall
Venting Applications



4" or 6" tube
diameter

Can be used as a
Dryer Vent

Pocket Depths
0.75", 1", 1.25", 1.5"

28.3 sq.in.
Max Open Area

Ability to
Caulk
around the perimeter

PREMIUM-SIZED FOOTPRINT

Measuring approximately 1.5" wider and taller than competing products, our design offers three distinct advantages: modern appearance, wide flanges for simplifying installation, and a sleeker profile (less protrusion from the wall).

INSTALLS WITH YOUR FAVORITE SIDING

Vinyl, Insulated Vinyl, Aluminum, & Composites: Faceplate has flange to hide siding cuts.
Fiber Cement & Engineered Wood: Baseplate design allows for caulking around the perimeter.

CONVERT THE VENT'S FUNCTIONALITY FROM EXHAUST TO INTAKE BY REMOVING THE FLAPPER'S SNAP-ON COVER

(SNAP-ON COVER INCLUDED)

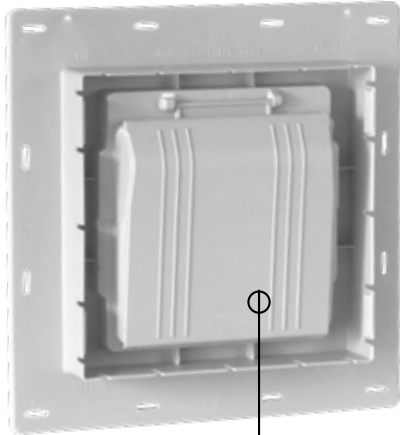

EXHAUST

The flapper (with cover attached) functions like a typical hooded vent. The center of gravity on the flapper is designed to sit tight against the backplate, virtually eliminating flutter. This is an ideal solution for dryer applications.

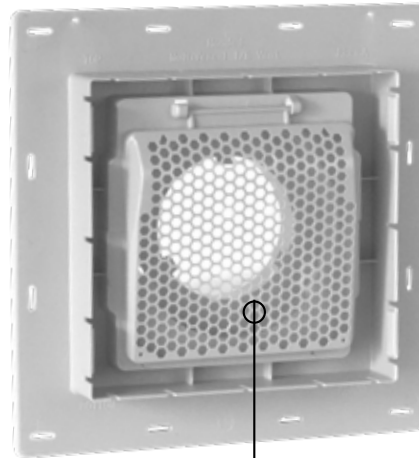

INTAKE

If an air intake application is needed, the snap-on cover can easily be removed from the flapper. Screw holes are present in each of the bottom corners for additional animal guard protection.

ACCEPTS MULTIPLE TUBE DIAMETERS

This utility vent accommodates various tube sizes, ensuring you have the right solution for any ducting application.

4" opening

Ready for 4" applications

6" opening

Cut along scribe line for 6" applications



DIRECTIONAL - MULTIVERSAL I/E VENT

Soffit & sidewall applications: Intake (furnace, hot water heater, and more) or exhaust (furnace, hot water heater, bathroom fan, range fan, and more)



11" x 10.25"
Outer Dimension



Intake/ Exhaust

Used for
Soffit, Sidewall, & Gable
Venting Applications



3", 4", or 6" tube
diameter

Pocket Depths
0.5", 0.75", 1", 1.25", 1.5"

28.3 sq.in.
Max Open Area

Ability to
Caulk
around the perimeter

PREMIUM-SIZED FOOTPRINT

Measuring approximately 1.5" wider and taller than competing products, our design offers three distinct advantages: modern appearance, wide flanges for simplifying installation, and a sleeker profile (less protrusion from the wall).

INSTALLS WITH YOUR FAVORITE SIDING

Vinyl, Insulated Vinyl, Aluminum, & Composites: Faceplate has flange to hide siding cuts.
Fiber Cement & Engineered Wood: Baseplate design allows for caulking around the perimeter.

A VERSATILE INTAKE/EXHAUST VENT IDEAL FOR SOFFITS OR SIDEWALLS

(UTILITY OR GABLE VENT)

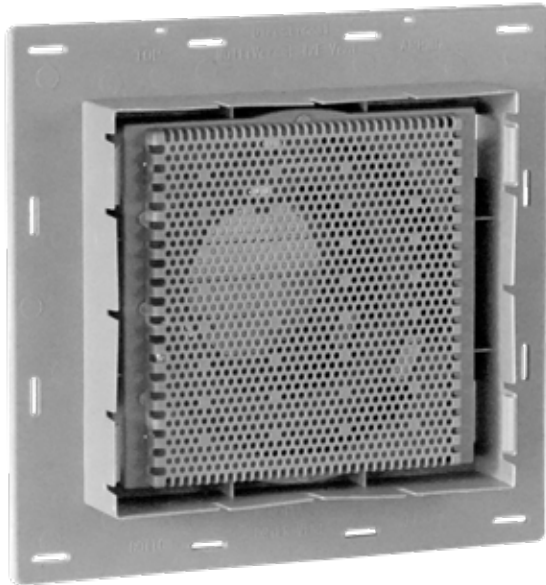

SOFFIT/SIDEWALL APPLICATIONS

With pocket depths ranging from 0.5"-1.5", our design can be used with both sidewall and soffit installations.

The louver face design ensures exit air is directed away from the structure, making it the best solution for soffit venting applications.

INTAKE/ EXHAUST APPLICATIONS

A screen is positioned behind the louvers, designed to accommodate both intake and exhaust applications.

GABLE VENT APPLICATIONS

Simply cut along the scribe line for the 6" opening to use as a gable vent (with 28.3 sq.in. of open area).

ACCEPTS MULTIPLE TUBE DIAMETERS

For your convenience, this utility vent accommodates various tube sizes, ensuring you have the right solution for any ducting application.

3" opening

Ready for 3" applications

4" opening

Cut along scribe line for 4" applications

6" opening

Cut along scribe line for 6" applications

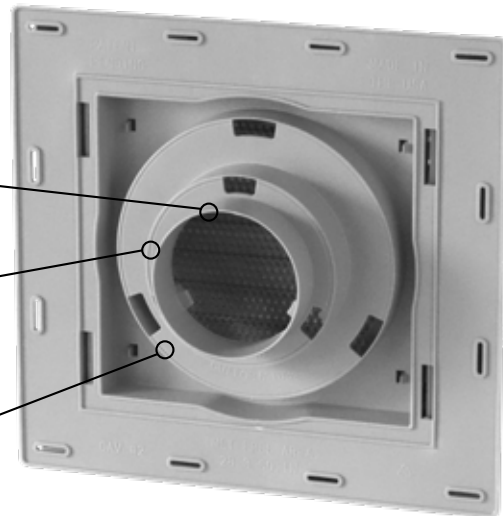

GABLE VENTS

17" x 23" GABLE VENT

Used for functional & decorative gable vent installations



16.5" x 22.5"
Outer Dimension



Intake/ Exhaust

Used for
Gable
Venting Applications

Pocket Depths
0.75", 1", 1.25", 1.5"

48 sq.in.
Open Area

Ability to
Caulk
around the perimeter

INSTALLS WITH YOUR FAVORITE SIDING

Vinyl, Insulated Vinyl, Aluminum, & Composites: Faceplate has flange to hide siding cuts.
Fiber Cement & Engineered Wood: Baseplate design allows for caulking around the perimeter.

ABILITY TO FLUSH MOUNT

The face plate is designed to be flush mounted to siding (like a shutter) in instances where the backplate isn't desired.

Wide louvers for a distinctive craftsman-inspired look



This modern design has wide trim and louvers, providing a premium, modern appearance. Elevate your home with this gable accent.

PART NUMBERS

STANDARD SHUTTERS

Nominal height	Raised Panel		Open Louver		Board & Batten	
	12" width	14.5" width	12" width	14.5" width	3 board joined (11" width)	4 board joined (14.5" width)
31"	PT40120310***	PT40140310***	PT41120310***	PT41140310***	PT42110310***	PT42140310***
35"	PT40120350***	PT40140350***	PT41120350***	PT41140350***	PT42110350***	PT42140350***
39"	PT40120390***	PT40140390***	PT41120390***	PT41140390***	PT42110390***	PT42140390***
43"	PT40120430***	PT40140430***	PT41120430***	PT41140430***	PT42110430***	PT42140430***
47"	PT40120470***	PT40140470***	PT41120470***	PT41140470***	PT42110470***	PT42140470***
51"	PT40120510***	PT40140510***	PT41120510***	PT41140510***	PT42110510***	PT42140510***
55"	PT40120550***	PT40140550***	PT41120550***	PT41140550***	PT42110550***	PT42140550***
59"	PT40120590***	PT40140590***	PT41120590***	PT41140590***	PT42110590***	PT42140590***
63"	PT40120630***	PT40140630***	PT41120630***	PT41140630***	PT42110630***	PT42140630***
67"	PT40120670***	PT40140670***	PT41120670***	PT41140670***	PT42110670***	PT42140670***
71"	PT40120710***	PT40140710***	PT41120710***	PT41140710***	PT42110710***	PT42140710***
75"	PT40120750***	PT40140750***	PT41120750***	PT41140750***	PT42110750***	PT42140750***
81"	PT40120810***	PT40140810***	PT41120810***	PT41140810***	PT42110810***	PT42140810***

- *** is a placeholder for the 3 digit color number (please see shutter colors on the next page)
- For custom shutter heights contact Pontiac Trail. Custom heights available: 28-81" in 0.5" increments

BLOCKS & VENTS

Mounting Blocks

Description	PN
Standard Mounting Block - 1 piece (6pcs/carton)	PT33040601***
Large Mounting Block - 1 piece (6pcs/carton)	PT35061001***
Split Mounting Block - 1 piece (6pcs/carton)	PT38050501***
Universal Electrical Box - 1 piece (6pcs/carton)	PT39050601555

- Must order in multiples of 6 pieces (the carton quantity)
- A Broken Box Fee applies to each item not ordered in carton quantity
- Products in the 6 piece carton are individually wrapped
- Full color offering (***) is a placeholder for the 3 digit color number)

Utility Vents

Description	PN
4" Hooded Vent - (1pc/carton)	PT24080701***
Hooded - MultiVersal I/E Vent - (1pc/carton)	PT26121101***
Directional - MultiVersal I/E Vent - (1pc/carton)	PT25101001***

- Full color offering (***) is a placeholder for the 3 digit color number)

Gable Vents

Description	PN
17x23 Gable Vent - (1pc/carton)	PT12172301***

- *** is a placeholder for the 3 digit color number
- Available in White only: A41, A43, A45 (please refer to the color match chart)

Accessories & Hardware

Description	PN
Shutter Plugs - 1 Kit (12/Kit)	PT46110012***
Shutter Screws & Caps - Kit (12/Kit)	PT46220012***
Replacement 3B Batten (Single Batten)	PT46453001***
Replacement 4B Batten (Single Batten)	PT46454001***
4" Vent Screen - 1 piece (6pcs/carton)	PT24080710999
6" Metal Tube - 1 piece (6pcs/carton)	PT20123456999

SHUTTER COLOR PALETTE

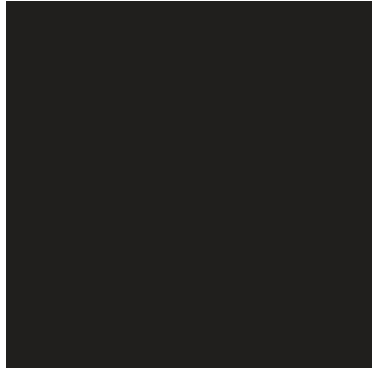

Black Cosmos (050)

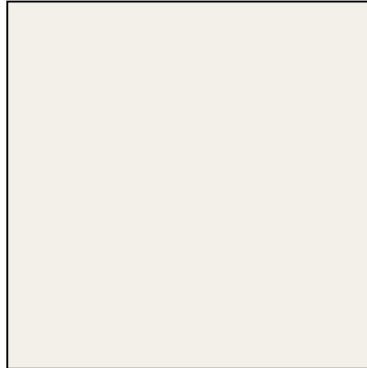

Dover White (930)

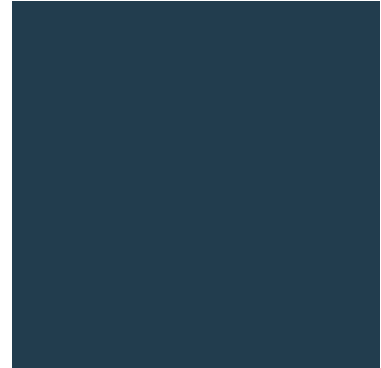

Navy Night Sky (104)

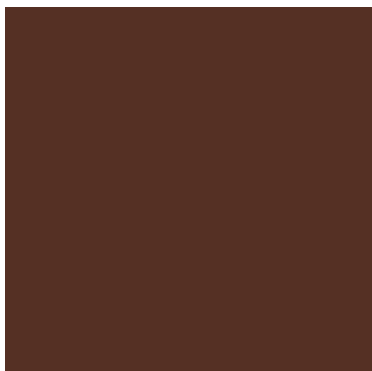

Dark Cherry Mocha (090)



Cornerstone Grey (410)



Coastal Sand Dune (730)



Coffee Bean (035)



Heathered Spruce (046)



Stone Mason Brown (022)

Printed colors may not accurately represent molded colors, please ask to see a color guide for the exact color.

Black Cosmos (050) and Dover White (930) shutter colors are paintable. Please refer to paint instructions.

PONTIAC TRAIL®

HOME DETAILS TO LIVE BY



Scan the QR code with your smartphone camera to access:

- Marketing Literature
- Sizing & Installation Guides
- Limited Lifetime Warranty



orders@pontiactrail.com
support@pontiactrail.com
800.558.2205
www.pontiactrail.com